

Opp No. 5

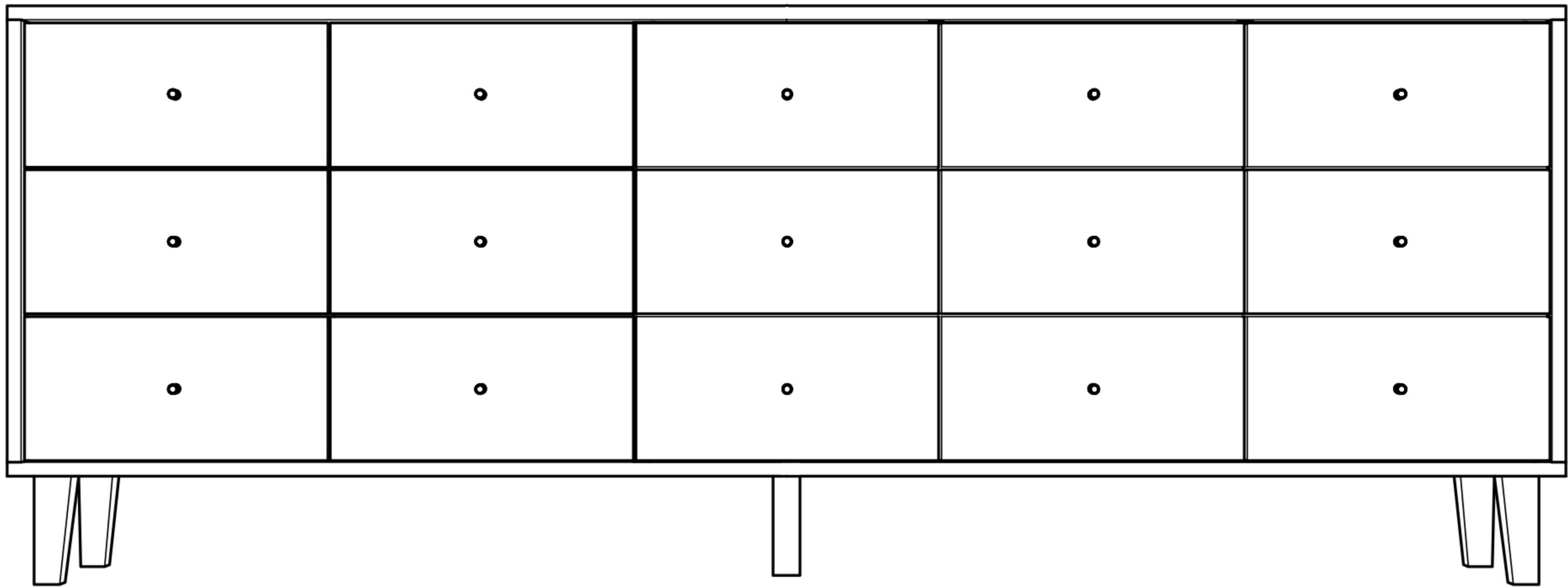

Opp No. 6

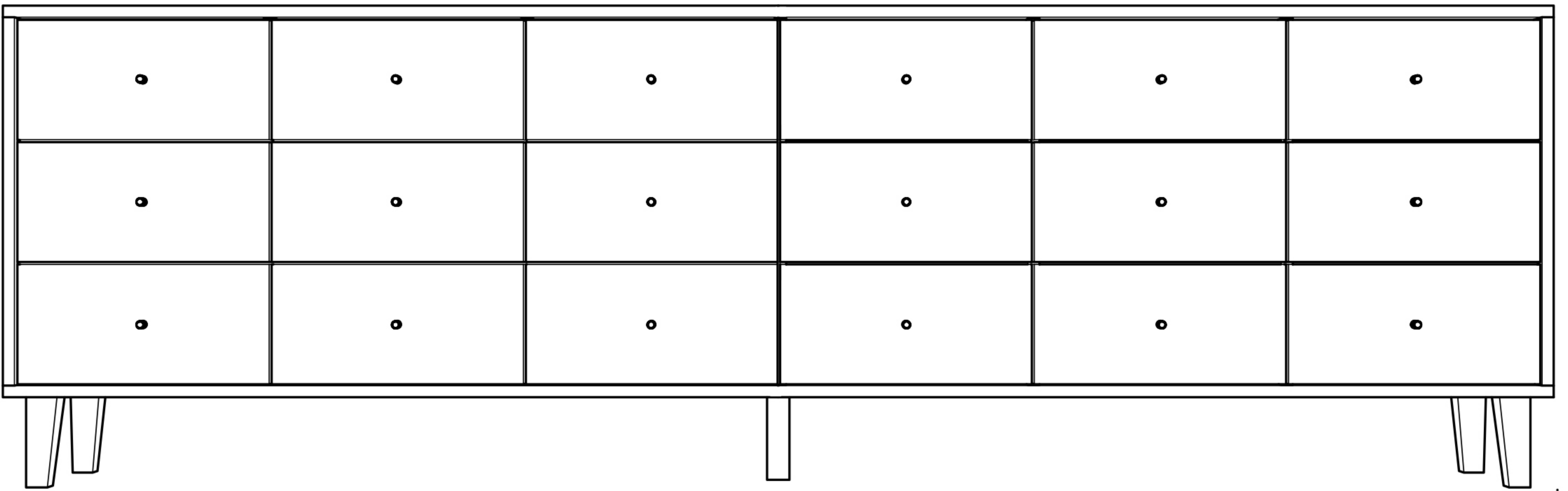

berke.

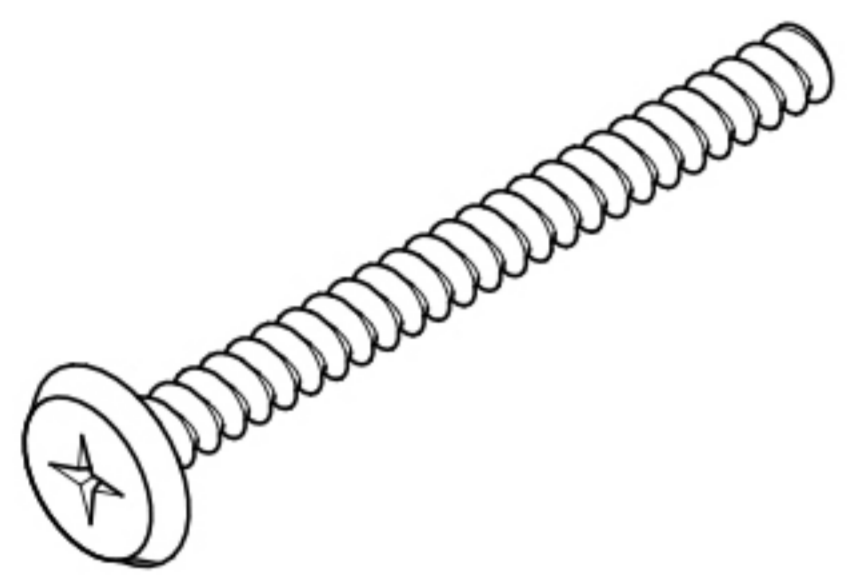
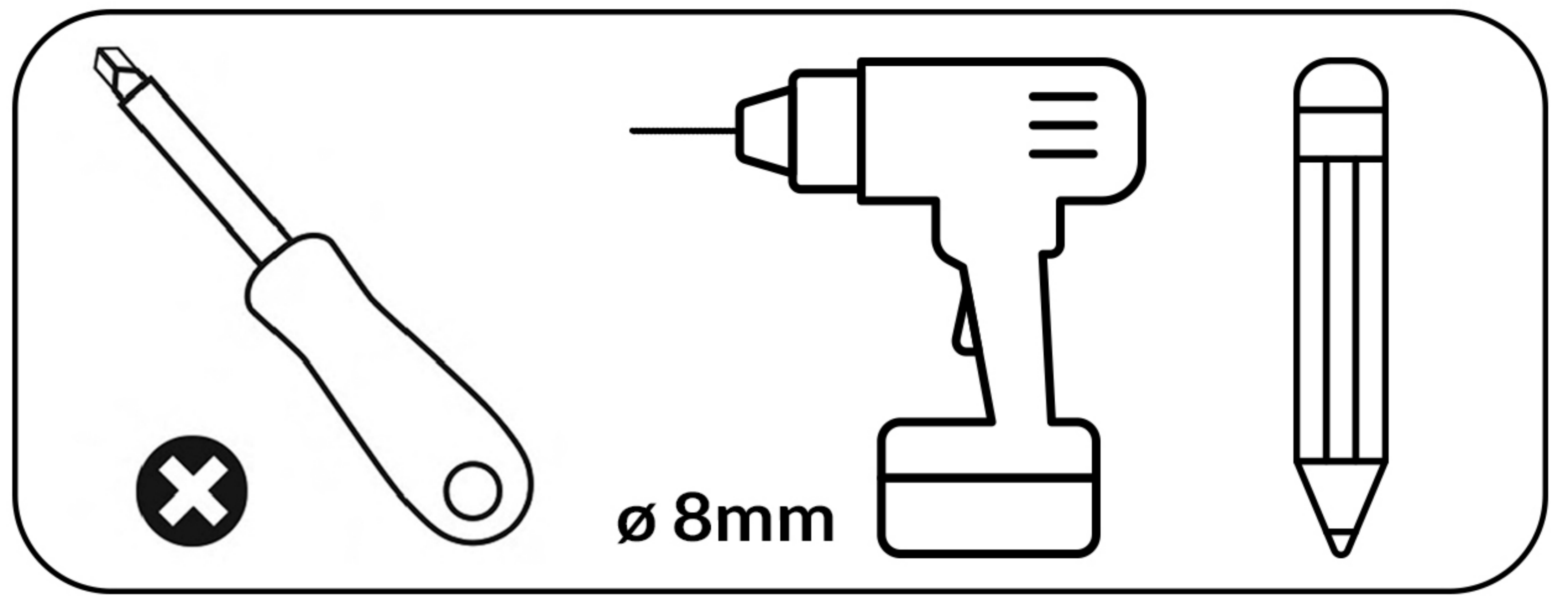
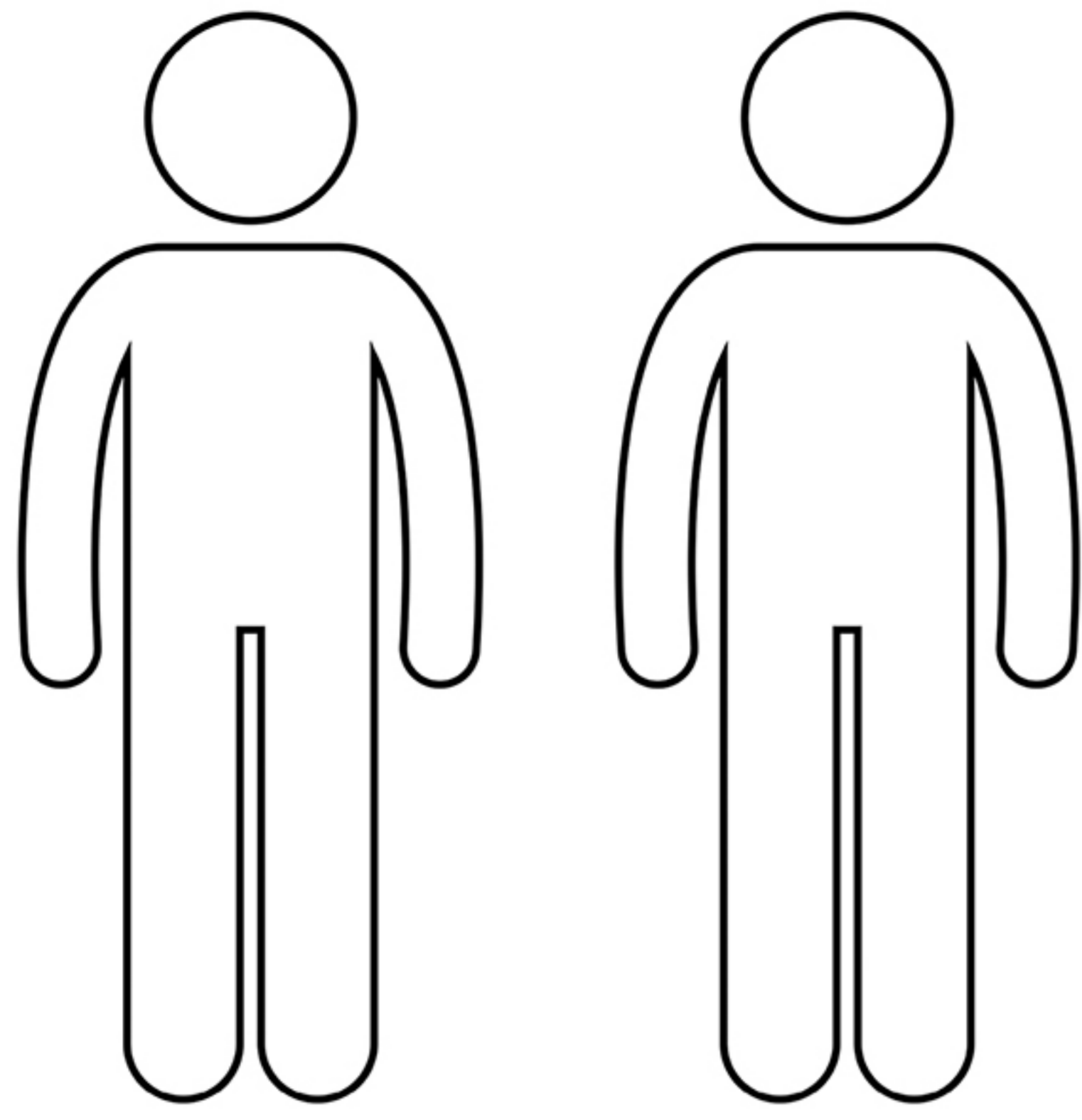

15x/18x
Opp No. 5/Opp No. 6

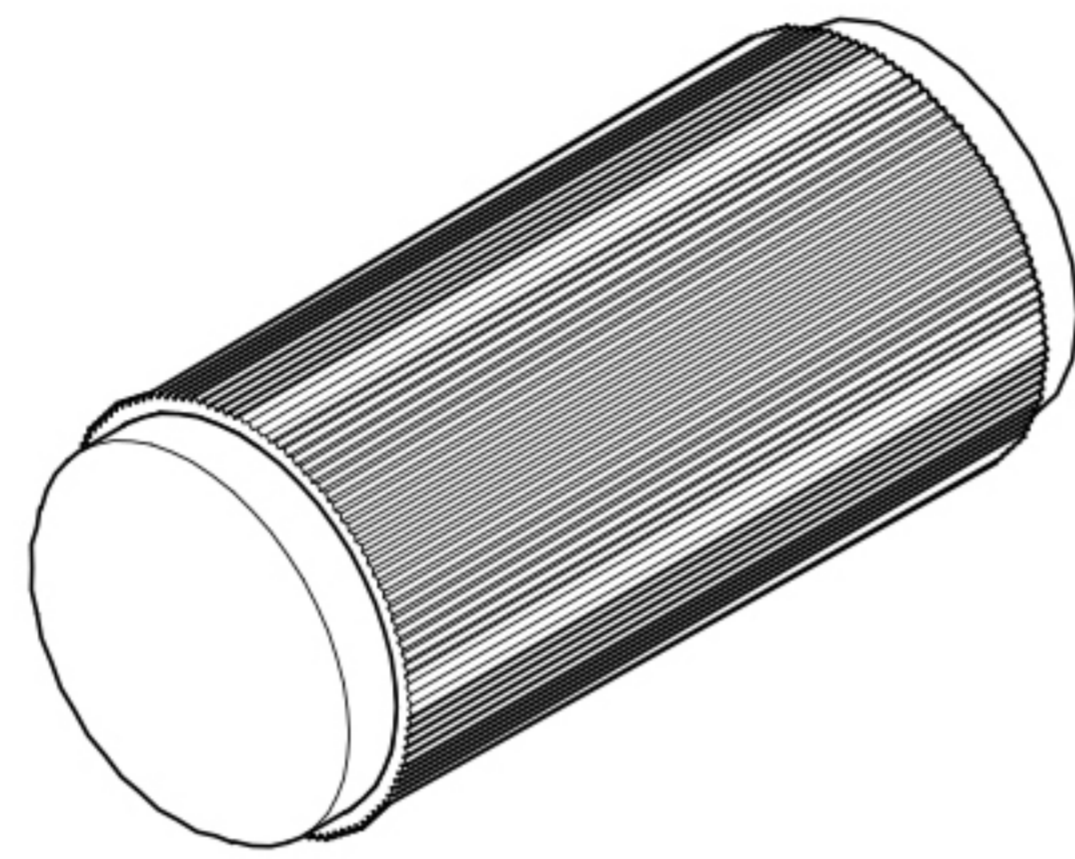

15x/18x
Opp No. 5/Opp No. 6

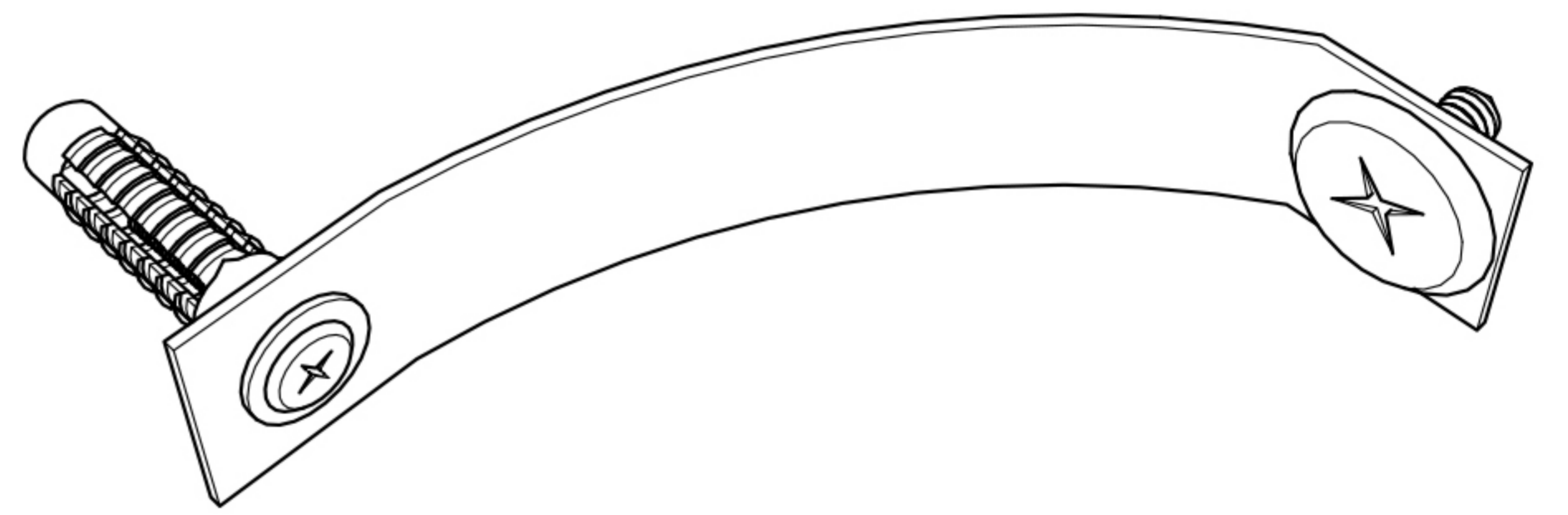

1x

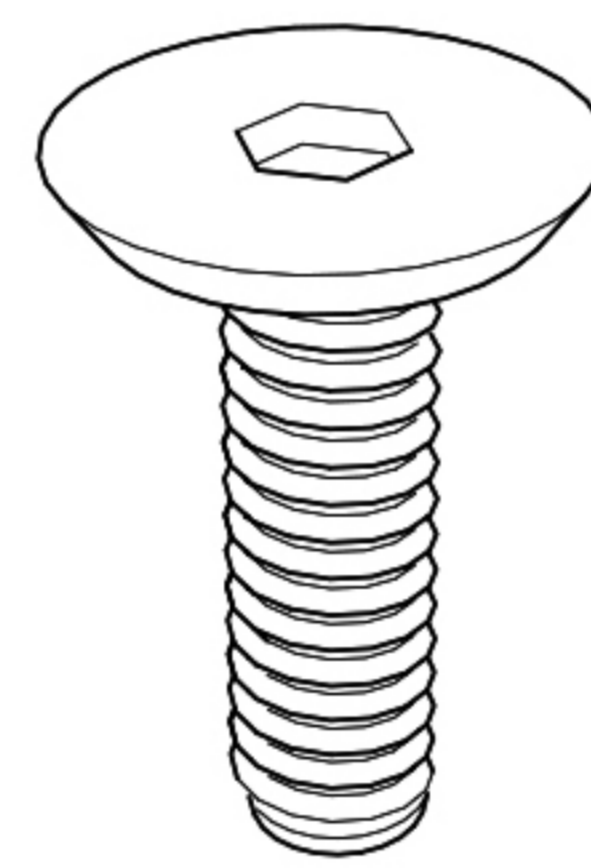

16x



1x

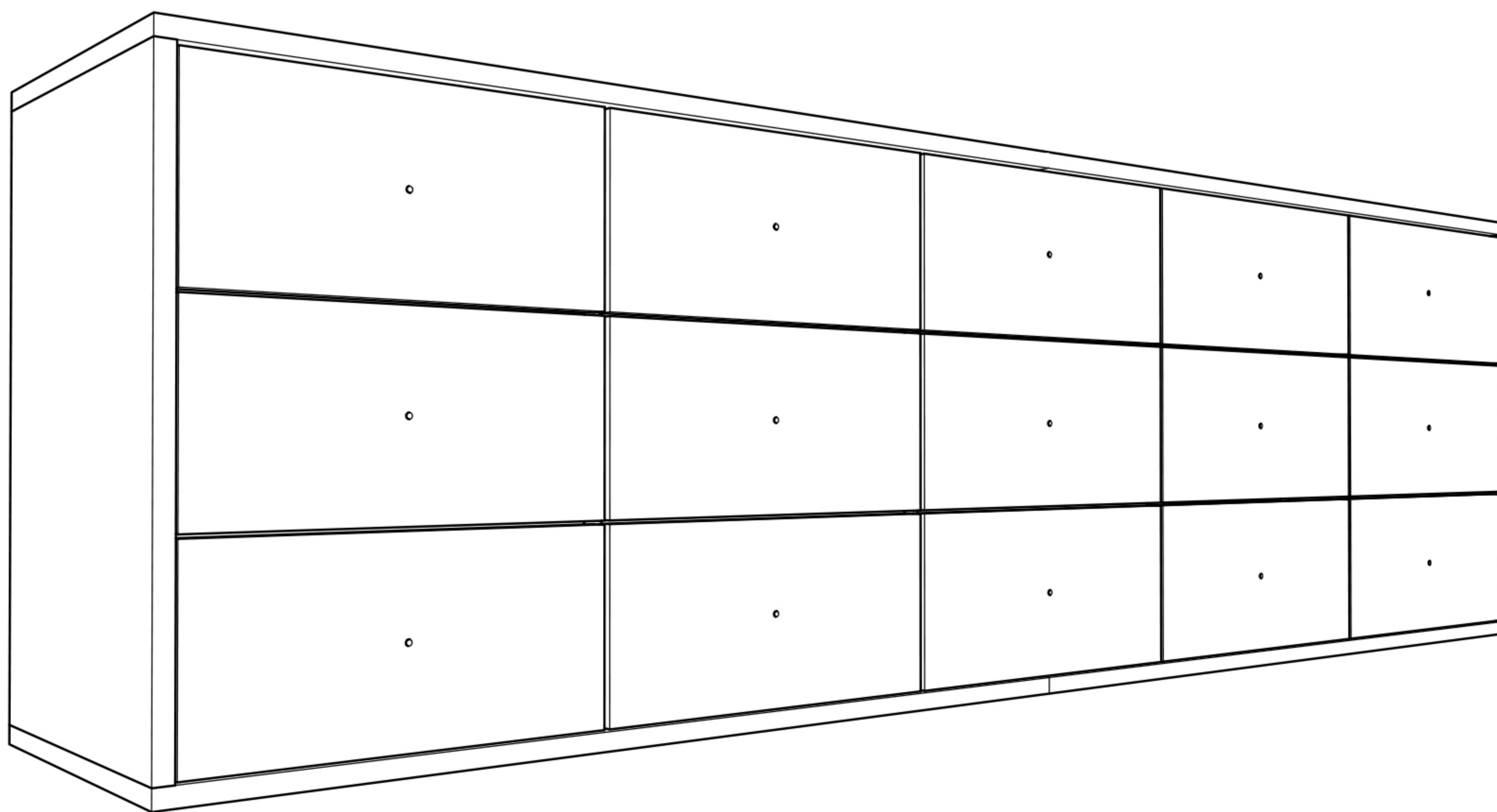

1x

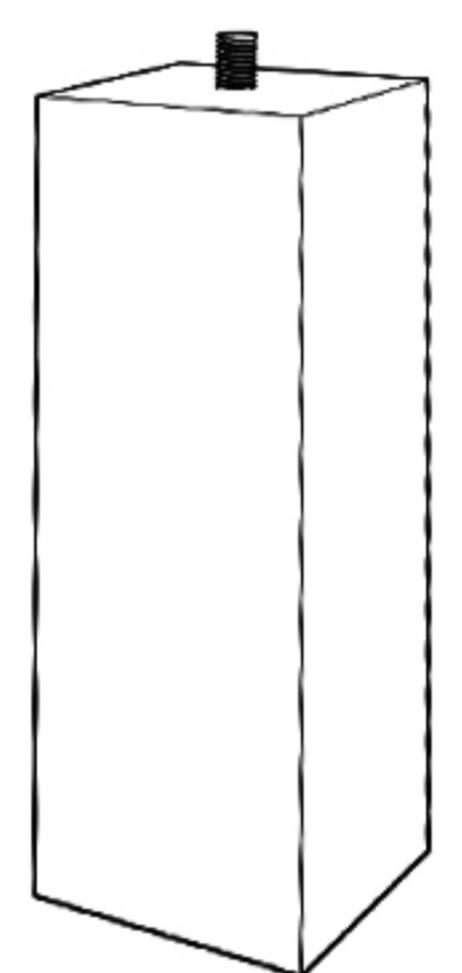

1x

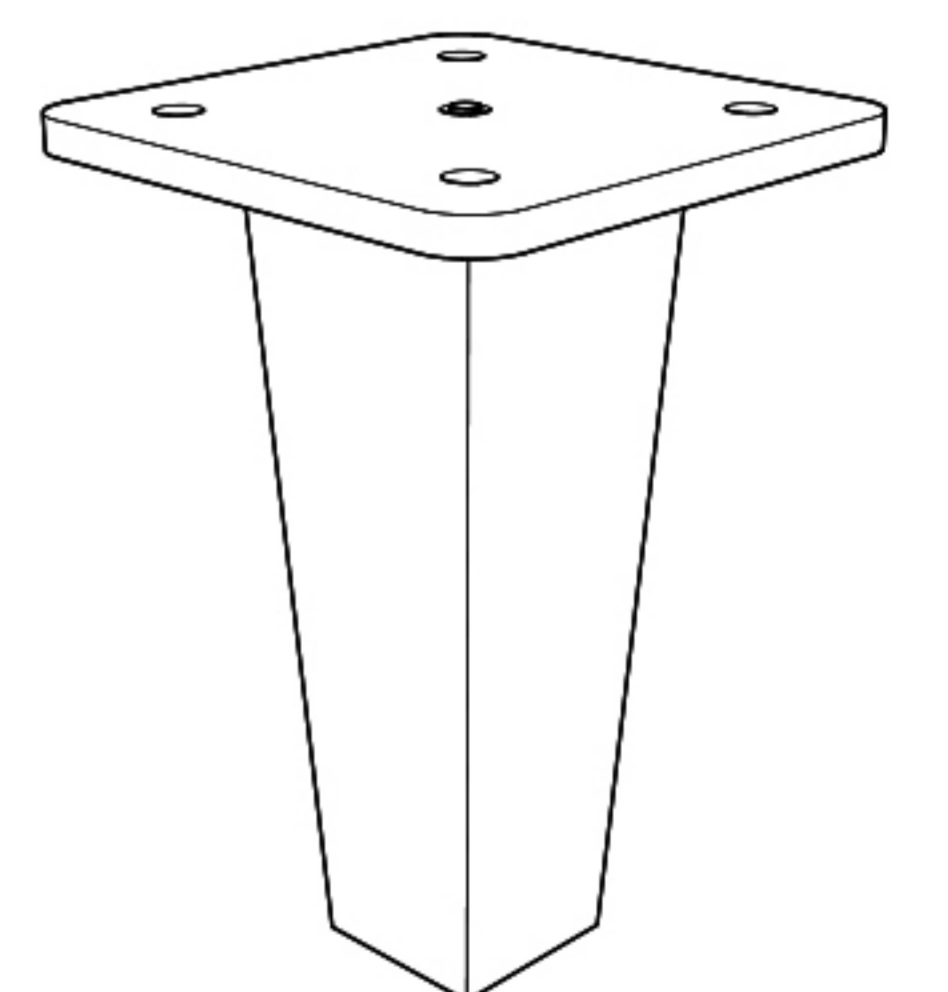

4x

3

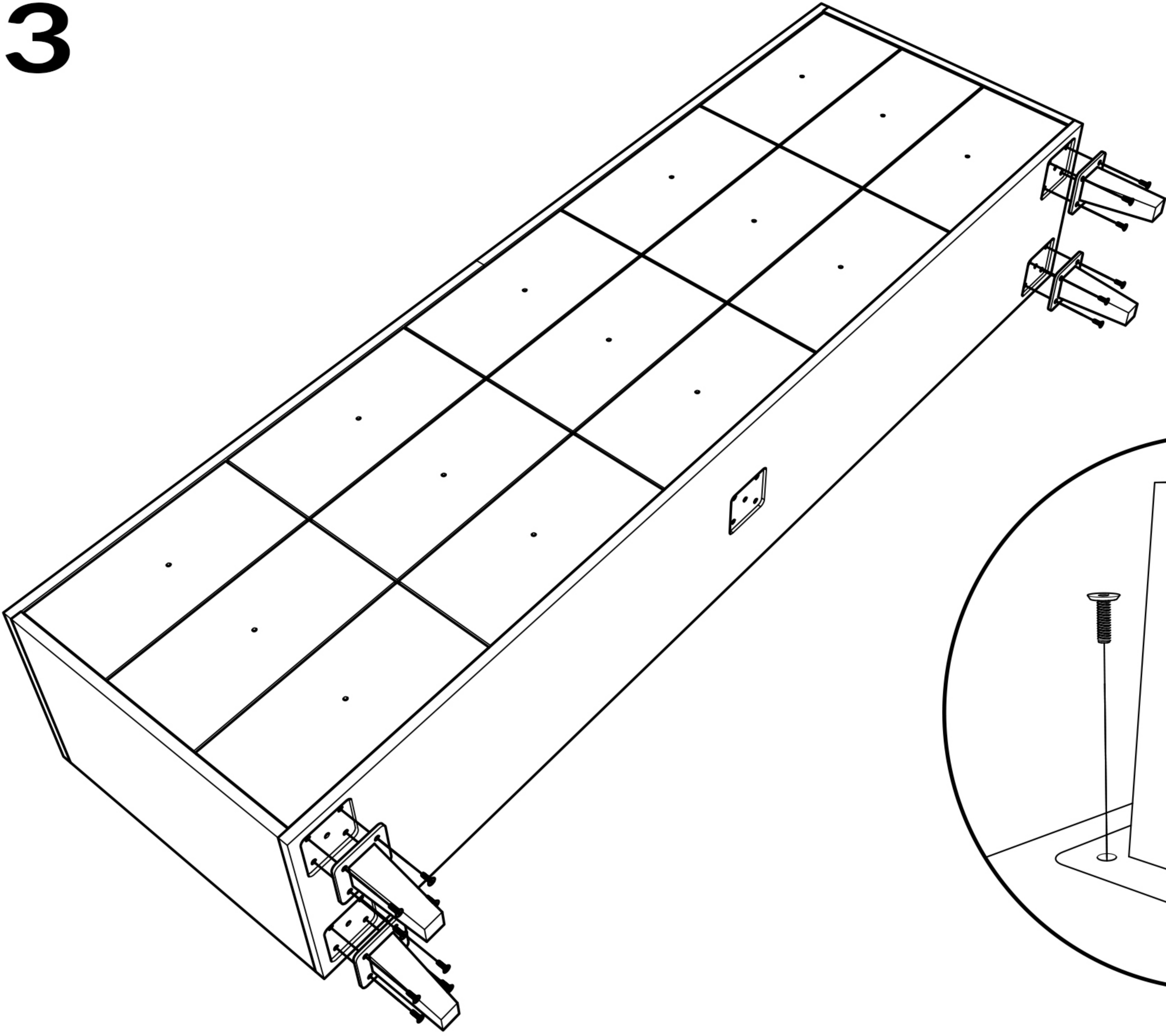

4

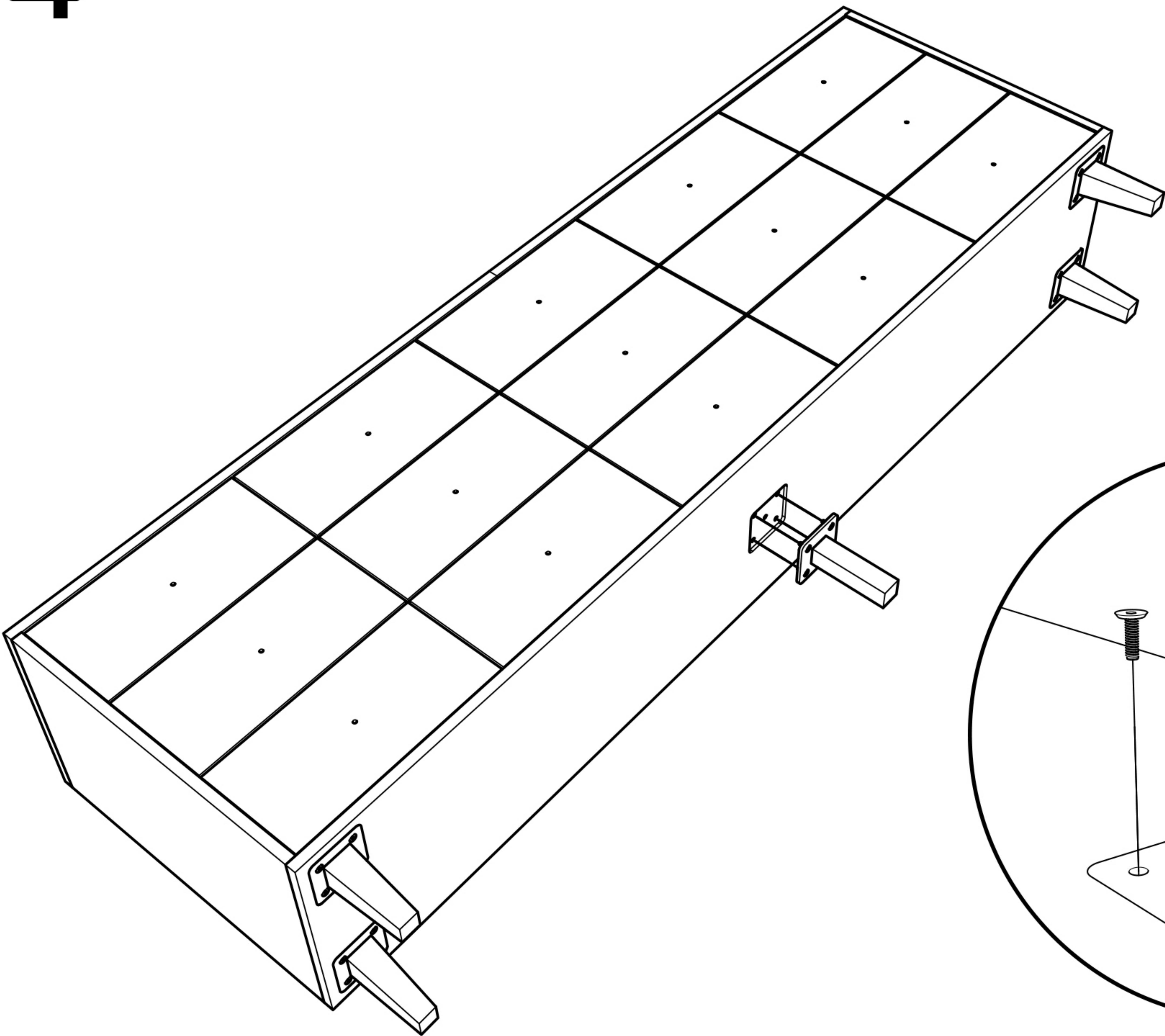

3

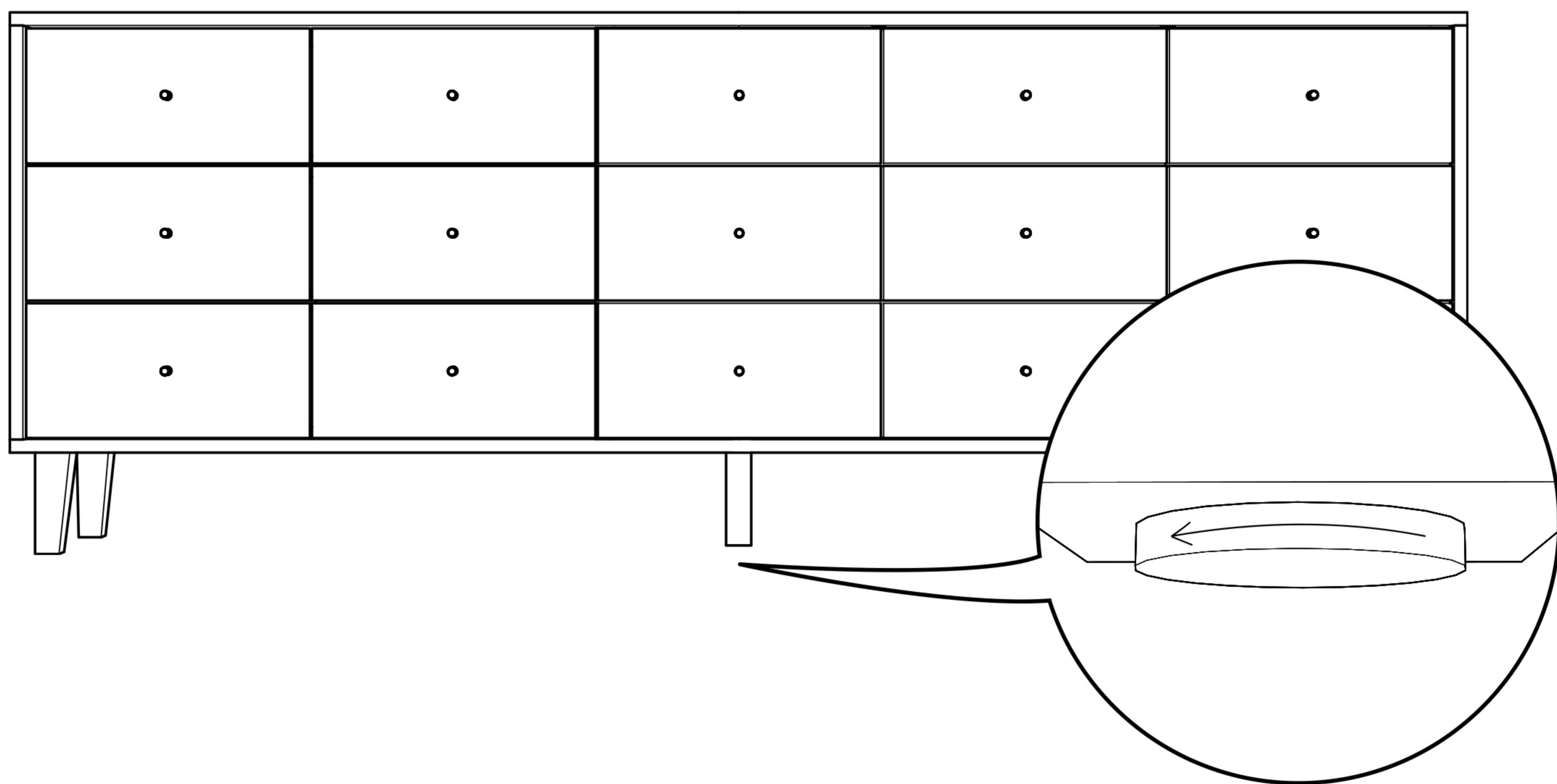

4

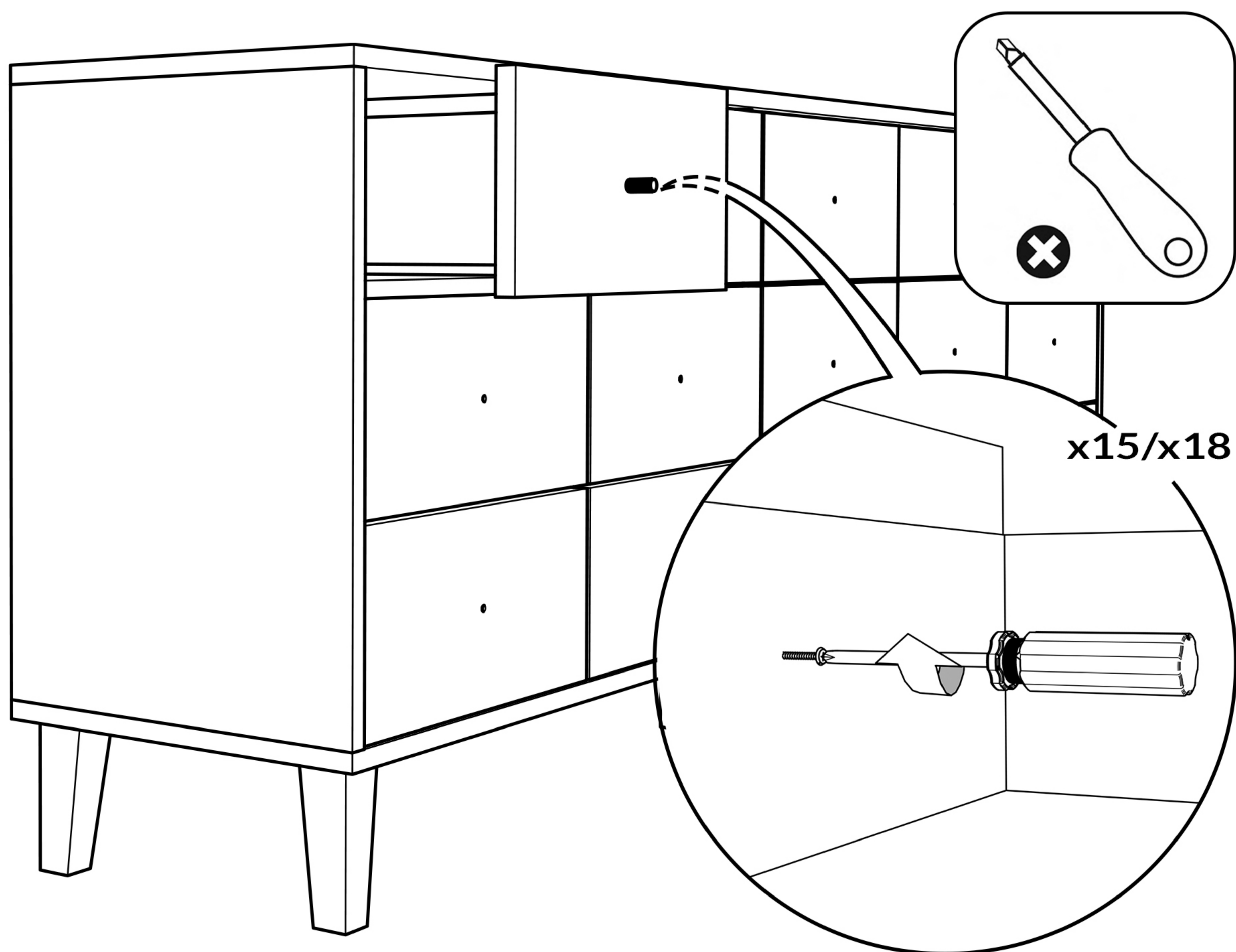

5

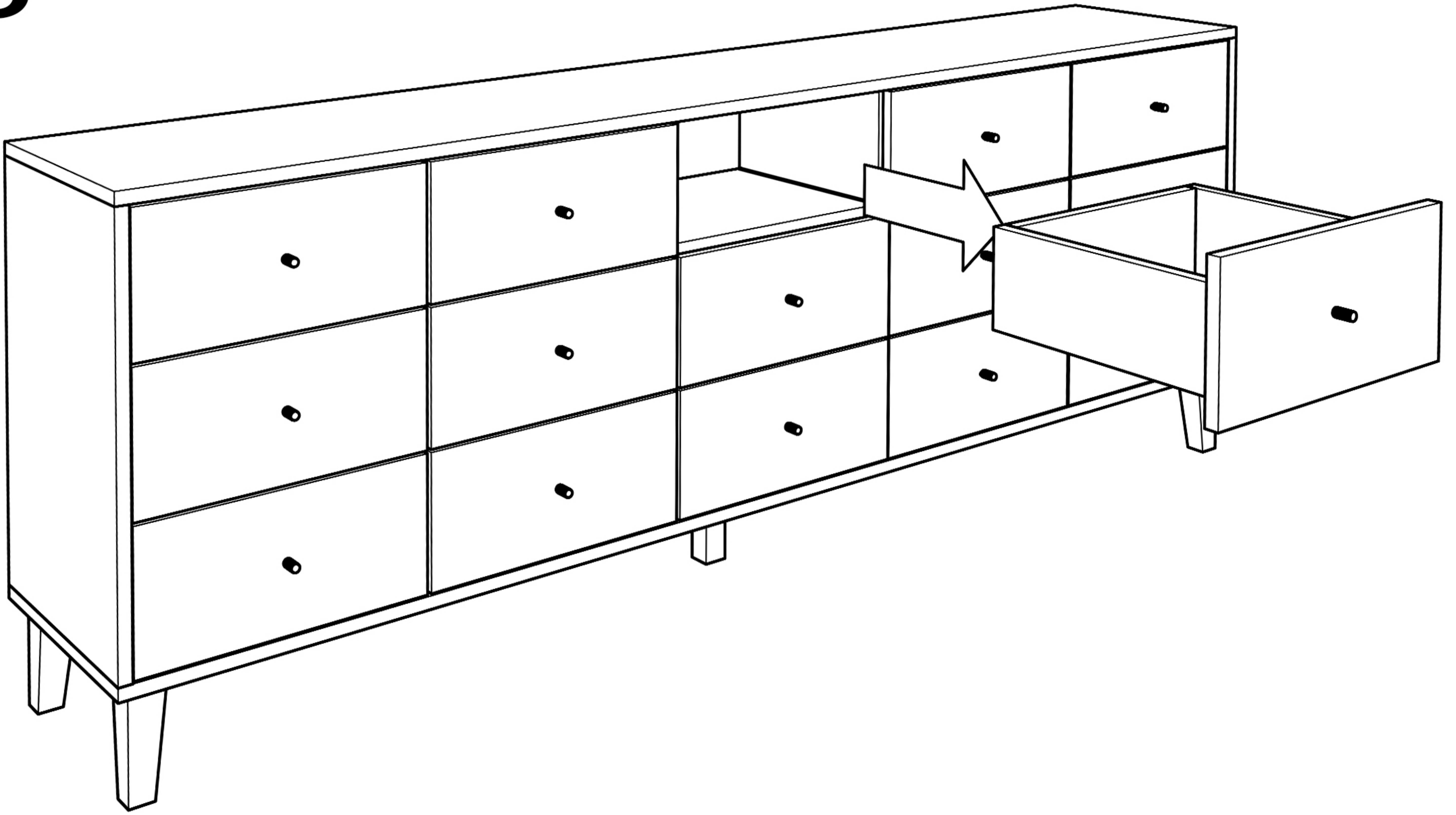

6

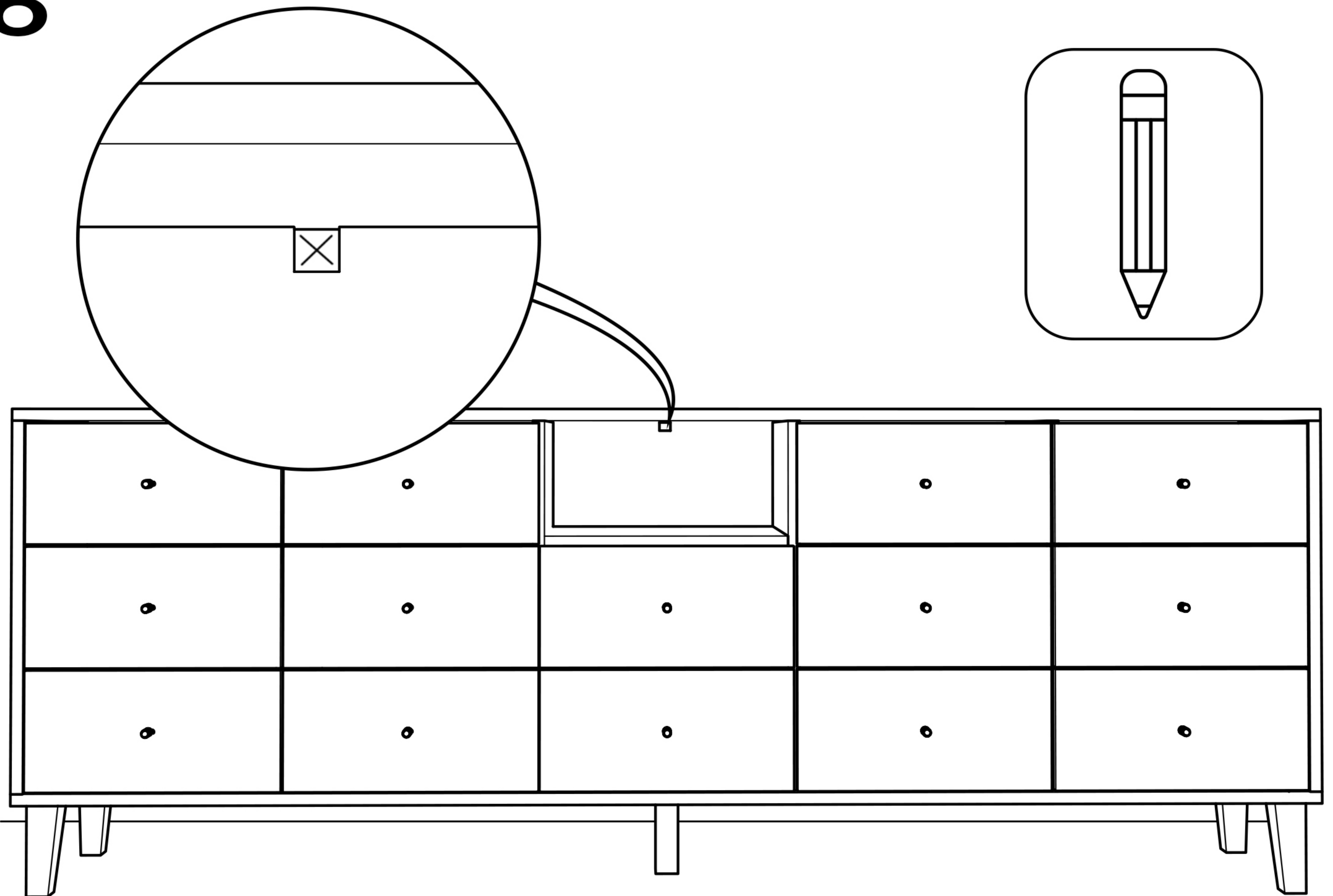

7

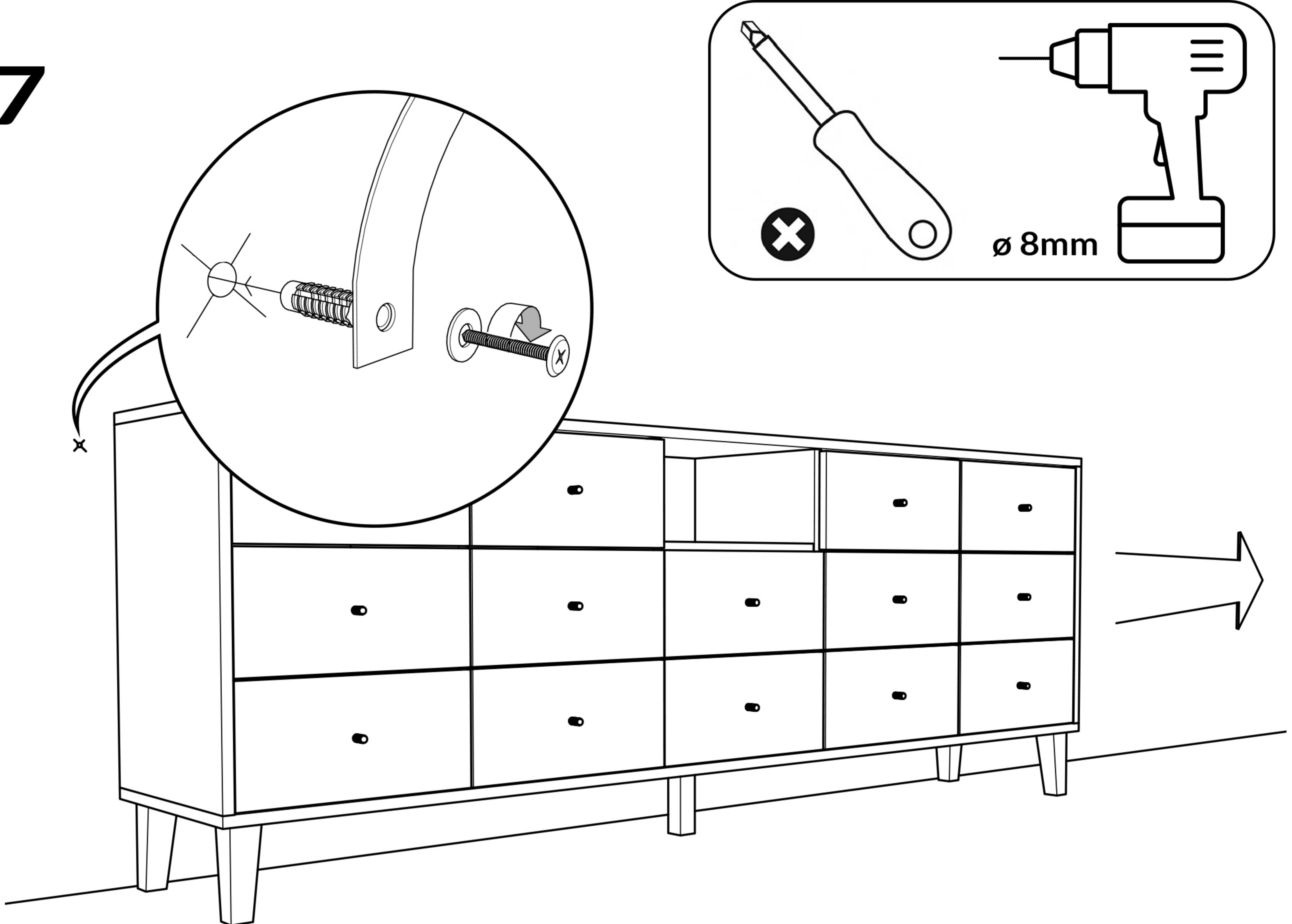

8

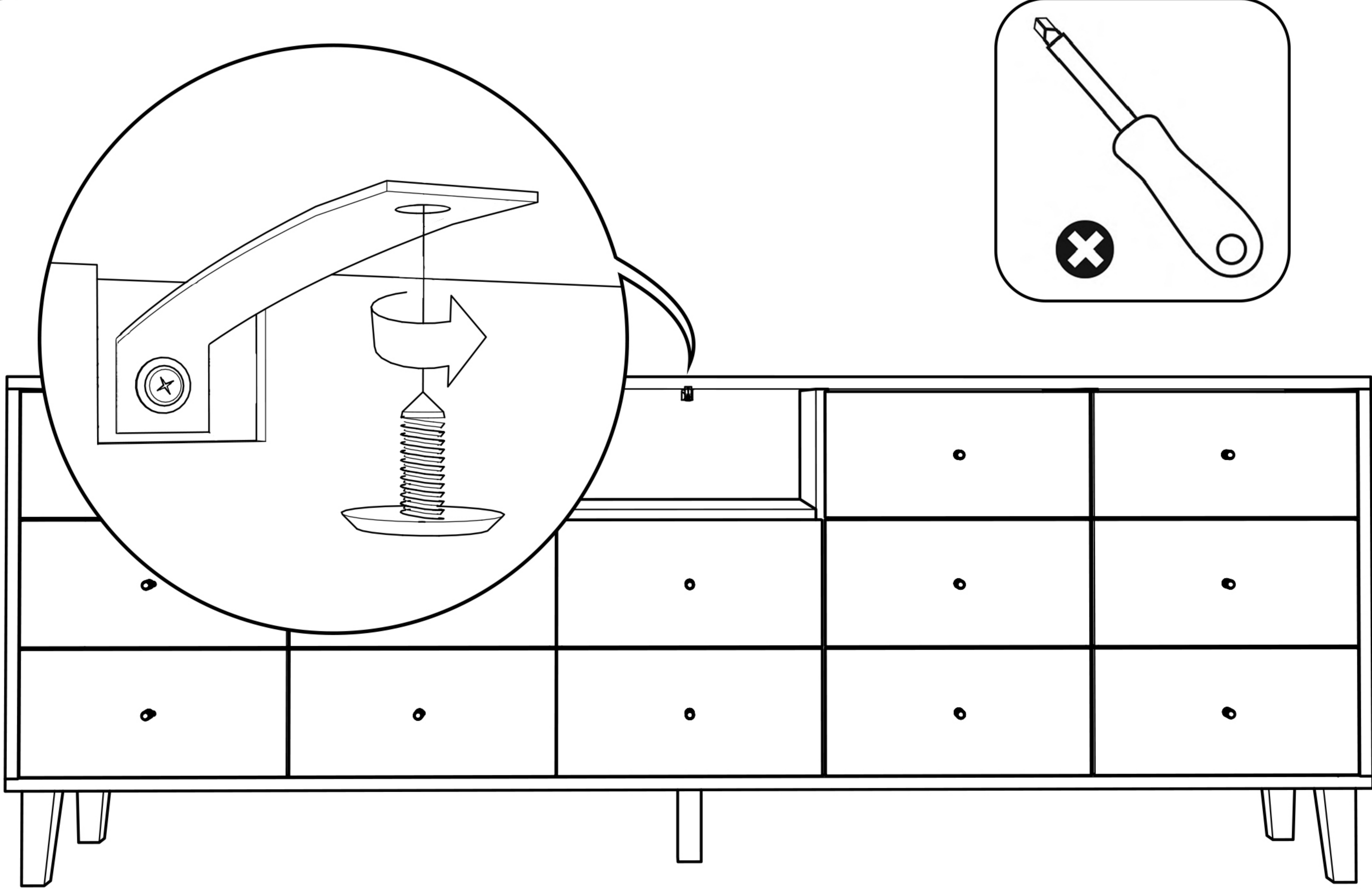

6

9

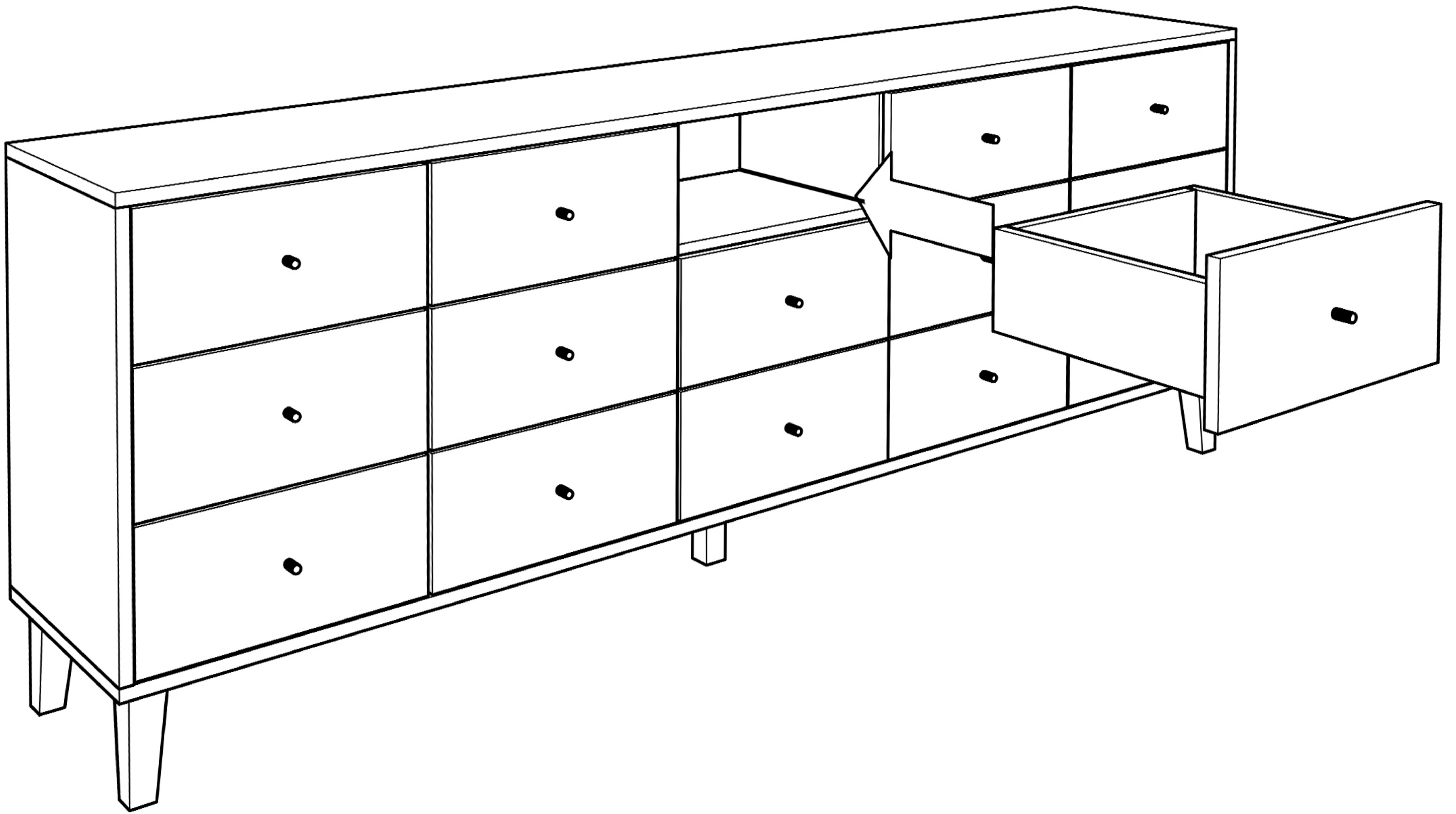

90102.1004